



Details are subject to change without notice.

ONE-CELL LI-ION BATTERY PROTECTION IC

FEATURES

- Ideal for One-Cell Rechargeable Li-Ion Battery Packs
- High Accuracy Voltage Detection
- Low Current Consumption:
3 μ A Supply Current (Typical)
0.1 μ A Shutdown Current
- 3-Level Over Current Detection:
Over-Current Level 1 /Over Current Level 2 / Short Circuit
- Wide Operating Temperature Range:
-40 $^{\circ}$ C to +85 $^{\circ}$ C
- Small SOT26 Package

GENERAL DESCRIPTION

The AAT8660 series are designed to protect one-cell rechargeable Li-Ion battery pack against over-charge, over-discharge, over-current and short circuit. They use CMOS process to provide high accuracy voltage detection and low current consumption.

Each of the AAT8660 devices incorporates voltage comparators, bandgap reference voltage generator, signal delay circuit, short circuit detector, and digital control circuit.

In the charge process, when the battery voltage is charged to a value greater than V_{C1} (Over-Charge Threshold Voltage), the output of C_{out} pin switches to the low level, i.e., the VN pin level. The output of C_{out} pin will switch to high level when the battery voltage falls lower than V_{C2} (Over-Charge Release Voltage), or when the charger is disconnected from the battery pack and the battery voltage level ranges between V_{C1} and V_{C2} .

During the discharge process, when the battery voltage drops to a value lower than V_{D1} (Over-Discharge Threshold Voltage), the output of D_{out} pin switches to low level immediately after the internal delay time elapses. The output of D_{out} pin will switch to high level when the battery voltage is at a level higher than V_{D2} (Over-Discharge Release Voltage).

PIN CONFIGURATION

TOP VIEW

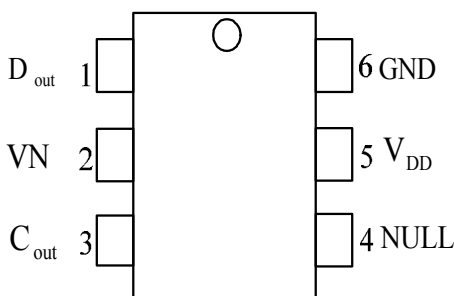

(SOT26)



Over current level 1 voltage (V_{OC1}) is used to monitor the amount of discharge current. If the discharge current is high enough to cause VN pin voltage increase to a value greater than V_{OC1} , the output of D_{out} pin will switch to a low level after a delay time t_{OC1} . If the load is removed from battery pack, the output of D_{out} will change to a high level again.

identical to a discharge current. If the short circuit current is high enough to cause VN pin voltage increase to greater than V_{short} , the output of D_{out} pin will move to the low level after a delay time t_{short} , and the output of D_{out} level will change to high when the load is removed from battery pack.

The mechanism of short circuit protection is

BLOCK DIAGRAM:

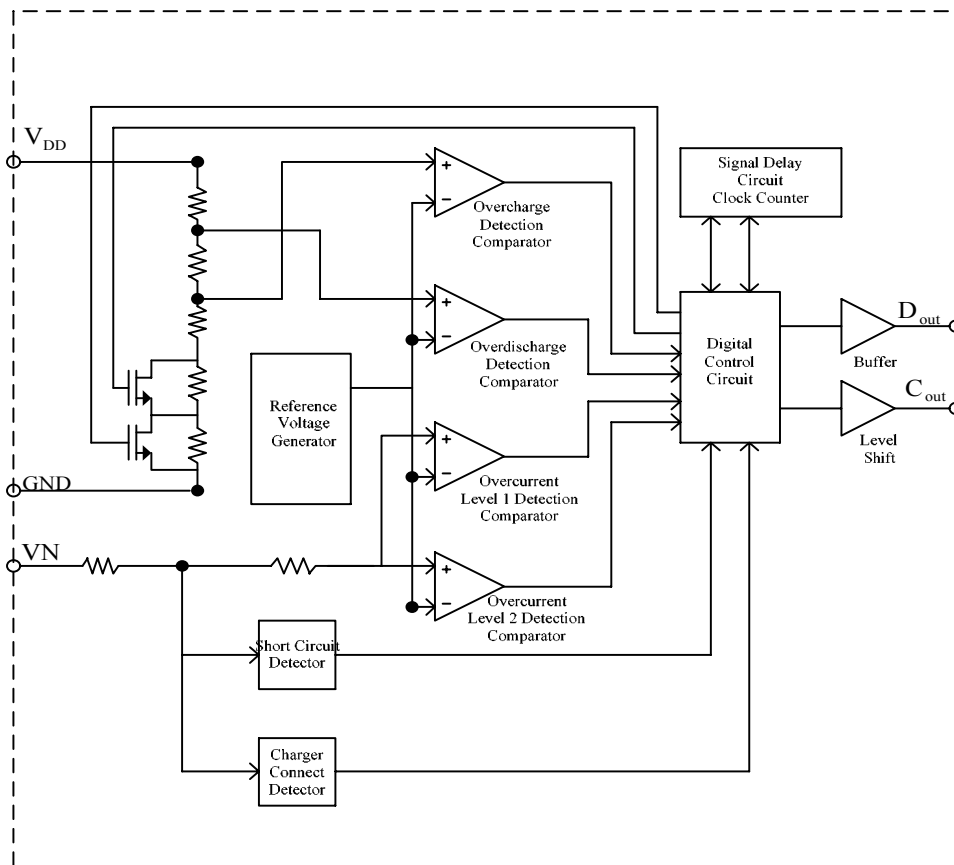

**PIN DESCRIPTION**

PIN NO	NAME	I/O	DESCRIPTION
1	D _{out}	O	Discharge Control Pin which Connects to External MOSFET Gate
2	VN	I	Voltage Detection Pin between VN and GND
3	C _{out}	O	Charge Control Pin which Connects to External MOSFET Gate.
4	NULL		Null Pad.
5	V _{DD}	I	Power Supply Input Pin
6	GND	I	Ground

ABSOLUTE MAXIMUM RATINGS

CHARACTERISTICS	SYMBOL	VALUE	UNIT
Supply Voltage	V _{DD}	-0.3 to 8.0	V
VN Pin Input Voltage	V _{VN}	V _{DD} - 20 to V _{DD} + 0.3	V
D _{out} Pin Output Voltage	V _{Dout}	-0.3 to V _{DD} + 0.3	V
C _{out} Pin Output Voltage	V _{Cout}	V _{VN} - 0.3 to V _{DD} + 0.3	V
Power Dissipation	P _d	150	mW
Operating Temperature Range	T _C	-40 to +85	°C
Storage Temperature Range	T _{storage}	-40 to +125	°C

RECOMMENDED OPERATING CONDITIONS

	TEST CONDITION	MIN	MAX	UNIT
Supply Voltage, V _{DD}	Voltage Defined as V _{DD} to GND	1.5	7.0	V
D _{out} Output Voltage		GND	V _{DD}	V
C _{out} Output Voltage		VN	V _{DD}	V

OPERATION VOLTAGE AND OPERATION CURRENT

PARAMETER	TEST CONDITION	MIN	TYP	MAX	UNIT
Supply Current at Normal Operation Mode	V _{DD} =3.3V; VN=0V; GND=0V		3.0	6.0	μA
Standby Current at Power Down Mode		-	-	0.1	μA
Operation Voltage between V _{DD} and VN		1.5		20.0	V



AAT8660A DETECTION VOLTAGE AND DELAY TIME (25° C)

PARAMETER	SYMBOL	TEST CONDITION	MIN	TYP	MAX	UNIT
Over Charge Threshold Voltage	V_{C1}	Detect Rising Edge of Supply Voltage	4.275	4.325	4.375	V
Over Charge Release Voltage	V_{C2}	Detect Falling Edge of Supply Voltage	$V_{C1}-0.35$	$V_{C1}-0.25$	$V_{C1}-0.15$	V
Over Discharge Threshold Voltage	V_{D1}	Detect Falling Edge of Supply Voltage	2.420	2.500	2.580	V
Over Discharge Release Voltage	V_{D2}	Detect Rising Edge of Supply Voltage	$V_{D1}+0.3$	$V_{D1}+0.4$	$V_{D1}+0.5$	V
Over Charge Delay Time	t_{C1}	$V_{DD} = 3.6V$ to $4.5V$	0.700	1.000	1.300	s
Over Discharge Delay Time	t_{D1}	$V_{DD} = 3.6V$ to $2.4V$	87.5	125.0	162.5	ms
Over Current Level 1 Detection Voltage	V_{OC1}	Detect Rising Edge of “VN” Pin Voltage (D_{out} Response with t_{OC1} Delay Time)	130	150	170	mV
Over Current Level 2 Detection Voltage	V_{OC2}	Detect Rising Edge of “VN” Pin Voltage (D_{out} Response with t_{OC2} Delay Time)	400	500	600	mV
Short Circuit Detection Voltage	V_{short}	$V_{DD} = 3.0V$, Detect Rising Edge of “VN” Pin Voltage (D_{out} Response with t_{short} Delay Time)	$V_{DD}-1.7$	$V_{DD}-1.3$	$V_{DD}-0.9$	V
Over Current Level 1 Detection Delay Time	t_{OC1}	$V_{DD} = 3.0V$	5.6	8.0	10.4	ms
Over Current Level 2 Detection Delay Time	t_{OC2}	Room Temp. \Rightarrow Low or High Temp. \Rightarrow $V_{DD} = 3.0V$	1.4 1.1	2.0 2.0	2.6 3.4	ms ms
Short Circuit Detection Delay Time	t_{short}	$V_{DD} = 3.0V$		10	50	μ s
Charger Detection Voltage	V_{CHR}	Detect Rising Edge of “ D_{out} ” Pin Voltage (when $V_{D1} < V_{DD} < V_{D2}$)	-2.0	-1.3	-0.6	V
C_{out} High Level Resistance	R_{COH}	$V_{DD} = 3.5V$; $C_{out} = 3.0V$; $VN = 0V$	1	2	10	k Ω
C_{out} Low Level Resistance	R_{COL}	$V_{DD} = 4.5V$; $C_{out} = 0.5V$; $VN = 0V$	150	602	2,380	k Ω
D_{out} High Level Resistance	R_{DOH}	$V_{DD} = 3.5V$; $D_{out} = 3.0V$; $VN = 0V$	2.5	5.0	10.0	k Ω
D_{out} Low Level Resistance	R_{DOL}	$V_{DD} = 1.8V$; $D_{out} = 0.5V$; $VN = 1.8V$	2.5	5.0	10.0	k Ω
Internal Resistance between VN and V_{DD}	R_{VND}	$V_{DD} = 1.8V$; $VN = 0V$	100	300	900	k Ω
Internal Resistance between VN and GND	R_{VNG}	$V_{DD} = 3.5V$; $VN = 3.5V$	10	20	40	k Ω



AAT8660B DETECTION VOLTAGE AND DELAY TIME (25)

PARAMETER	SYMBOL	TEST CONDITION	MIN	TYP	MAX	UNIT
Over Charge Threshold Voltage	V_{C1}	Detect Rising Edge of Supply Voltage	4.300	4.350	4.400	V
Over Charge Release Voltage	V_{C2}	Detect Falling Edge of Supply Voltage	$V_{C1}-0.30$	$V_{C1}-0.20$	$V_{C1}-0.10$	V
Over Discharge Threshold Voltage	V_{D1}	Detect Falling Edge of Supply Voltage	2.220	2.300	2.380	V
Over Discharge Release Voltage	V_{D2}	Detect Rising Edge of Supply Voltage	$V_{D1}+0.6$	$V_{D1}+0.7$	$V_{D1}+0.8$	V
Over Charge Delay Time	t_{C1}	$V_{DD} = 3.6V$ to $4.5V$	0.088	0.125	0.163	s
Over Discharge Delay Time	t_{D1}	$V_{DD} = 3.6V$ to $2.4V$	22.4	32.0	41.6	ms
Over Current Level 1 Detection Voltage	V_{OC1}	Detect Rising Edge of “VN” Pin Voltage (D_{out} Response with t_{OC1} Delay Time)	130	150	170	mV
Over Current Level 2 Detection Voltage	V_{OC2}	Detect Rising Edge of “VN” Pin Voltage (D_{out} Response with t_{OC2} Delay Time)	400	500	600	mV
Short Circuit Detection Voltage	V_{short}	$V_{DD} = 3.0V$, Detect Rising Edge of “VN” Pin Voltage (D_{out} Response with t_{short} Delay Time)	$V_{DD}-1.7$	$V_{DD}-1.3$	$V_{DD}-0.9$	V
Over Current Level 1 Detection Delay Time	t_{OC1}	$V_{DD} = 3.0V$	2.8	4.0	5.2	ms
Over Current Level 2 Detection Delay Time	t_{OC2}	Room Temp. \Rightarrow Low or High Temp. \Rightarrow $V_{DD} = 3.0V$	1.4 1.1	2.0 2.0	2.6 3.4	ms ms
Short Circuit Detection Delay Time	t_{short}	$V_{DD} = 3.0V$		10	50	μ s
Charger Detection Voltage	V_{CHR}	Detect Rising Edge of “ D_{out} ” Pin Voltage (when $V_{D1} < V_{DD} < V_{D2}$)	-2.0	-1.3	-0.6	V
C_{out} High Level Resistance	R_{COH}	$V_{DD} = 3.5V$; $C_{OUT} = 3.0V$; $VN = 0V$	1	2	10	k Ω
C_{out} Low Level Resistance	R_{COL}	$V_{DD} = 4.5V$; $C_{OUT} = 0.5V$; $VN = 0V$	150	602	2,380	k Ω
D_{out} High Level Resistance	R_{DOH}	$V_{DD} = 3.5V$; $D_{out} = 3.0V$; $VN = 0V$	2.5	5.0	10.0	k Ω
D_{out} Low Level Resistance	R_{DOL}	$V_{DD} = 1.8V$; $D_{out} = 0.5V$; $VN = 1.8V$	2.5	5.0	10.0	k Ω
Internal Resistance between VN and V_{DD}	R_{VND}	$V_{DD} = 1.8V$; $VN = 0V$	100	300	900	k Ω
Internal Resistance between VN and GND	R_{VNG}	$V_{DD} = 3.5V$; $VN = 3.5V$	10	20	40	k Ω



AAT8660C DETECTION VOLTAGE AND DELAY TIME (25)

PARAMETER	SYMBOL	TEST CONDITION	MIN	TYP	MAX	UNIT
Over Charge Threshold Voltage	V_{C1}	Detect Rising Edge of Supply Voltage	4.250	4.300	4.350	V
Over Charge Release Voltage	V_{C2}	Detect Falling Edge of Supply Voltage	$V_{C1}-0.30$	$V_{C1}-0.20$	$V_{C1}-0.10$	V
Over Discharge Threshold Voltage	V_{D1}	Detect Falling Edge of Supply Voltage	2.220	2.300	2.380	V
Over Discharge Release Voltage	V_{D2}	Detect Rising Edge of Supply Voltage	$V_{D1}-0.08$	V_{D1}	$V_{D1}+0.08$	V
Over Charge Delay Time	t_{C1}	$V_{DD} = 3.6V$ to $4.5V$	0.700	1.000	1.300	s
Over Discharge Delay Time	t_{D1}	$V_{DD} = 3.6V$ to $2.4V$	87.5	125.0	162.5	ms
Over Current Level 1 Detection Voltage	V_{OC1}	Detect Rising Edge of “VN” Pin Voltage (D_{out} Response with t_{OC1} Delay Time)	80	100	120	mV
Over Current Level 2 Detection Voltage	V_{OC2}	Detect Rising Edge of “VN” Pin Voltage (D_{out} Response with t_{OC2} Delay Time)	400	480	600	mV
Short Circuit Detection Voltage	V_{short}	$V_{DD} = 3.0V$, Detect Rising Edge of “VN” Pin Voltage (D_{out} Response with t_{short} Delay Time)	$V_{DD}-1.7$	$V_{DD}-1.3$	$V_{DD}-0.9$	V
Over Current Level 1 Detection Delay Time	t_{OC1}	$V_{DD} = 3.0V$	5.6	8.0	10.4	ms
Over Current Level 2 Detection Delay Time	t_{OC2}	Room Temp. \Rightarrow Low or High Temp. \Rightarrow $V_{DD} = 3.0V$	1.4 1.1	2.0 2.0	2.6 3.4	ms ms
Short Circuit Detection Delay Time	t_{short}	$V_{DD} = 3.0V$		10	50	μ S
Charger Detection Voltage	V_{CHR}	Detect Rising Edge of “ D_{out} ” Pin Voltage (when $V_{D1} < V_{DD} < V_{D2}$)	-2.0	-1.3	-0.6	V
C_{out} High Level Resistance	R_{COH}	$V_{DD} = 3.5V$; $C_{out} = 3.0V$; $VN = 0V$	1	2	10	k Ω
C_{out} Low Level Resistance	R_{COL}	$V_{DD} = 4.5V$; $C_{out} = 0.5V$; $VN = 0V$	150	602	2,380	k Ω
D_{out} High Level Resistance	R_{DOH}	$V_{DD} = 3.5V$; $D_{out} = 3.0V$; $VN = 0V$	2.5	5.0	10.0	k Ω
D_{out} Low Level Resistance	R_{DOL}	$V_{DD} = 1.8V$; $D_{out} = 0.5V$; $VN = 1.8V$	2.5	5.0	10.0	k Ω
Internal Resistance between VN and V_{DD}	R_{VND}	$V_{DD} = 1.8V$; $VN = 0V$	100	300	900	k Ω
Internal Resistance between VN and GND	R_{VNG}	$V_{DD} = 3.5V$; $VN = 3.5V$	10	20	40	k Ω



AAT8660D DETECTION VOLTAGE AND DELAY TIME (25)

PARAMETER	SYMBOL	TEST CONDITION	MIN	TYP	MAX	UNIT
Over Charge Threshold Voltage	V_{C1}	Detect Rising Edge of Supply Voltage	4.230	4.280	4.330	V
Over Charge Release Voltage	V_{C2}	Detect Falling Edge of Supply Voltage	$V_{C1}-0.30$	$V_{C1}-0.20$	$V_{C1}-0.10$	V
Over Discharge Threshold Voltage	V_{D1}	Detect Falling Edge of Supply Voltage	2.201	2.281	2.361	V
Over Discharge Release Voltage	V_{D2}	Detect Rising Edge of Supply Voltage	$V_{D1}-0.08$	V_{D1}	$V_{D1}+0.08$	V
Over Charge Delay Time	t_{C1}	$V_{DD} = 3.6V$ to $4.5V$	0.700	1.000	1.300	s
Over Discharge Delay Time	t_{D1}	$V_{DD} = 3.6V$ to $2.4V$	87.5	125.0	162.5	ms
Over Current Level 1 Detection Voltage	V_{OC1}	Detect Rising Edge of “VN” Pin Voltage (D_{out} Response With t_{OC1} Delay Time)	110	130	150	mV
Over Current Level 2 Detection Voltage	V_{OC2}	Detect Rising Edge of “VN” Pin Voltage (D_{out} Response with t_{OC2} Delay Time)	400	490	600	mV
Short Circuit Detection Voltage	V_{short}	$V_{DD} = 3.0V$, Detect Rising Edge of “VN” Pin Voltage (D_{out} Response with t_{short} Delay Time)	$V_{DD}-1.7$	$V_{DD}-1.3$	$V_{DD}-0.9$	V
Over Current Level 1 Detection Delay Time	t_{OC1}	$V_{DD} = 3.0V$	5.6	8.0	10.4	ms
Over Current Level 2 Detection Delay Time	t_{OC2}	Room Temp. \Rightarrow Low or High Temp. \Rightarrow $V_{DD} = 3.0V$	1.4 1.1	2.0 2.0	2.6 3.4	ms ms
Short Circuit Detection Delay Time	t_{short}	$V_{DD} = 3.0V$		10	50	μ s
Charger Detection Voltage	V_{CHR}	Detect Rising Edge of “ D_{out} ” Pin Voltage (when $V_{D1} < V_{DD} < V_{D2}$)	-2.0	-1.3	-0.6	V
C_{out} High Level Resistance	R_{COH}	$V_{DD} = 3.5V$; $C_{out} = 3.0V$; $VN = 0V$	1	2	10	k Ω
C_{out} Low Level Resistance	R_{COL}	$V_{DD} = 4.5V$; $C_{out} = 0.5V$; $VN = 0V$	150	602	2,380	k Ω
D_{out} High Level Resistance	R_{DOH}	$V_{DD} = 3.5V$; $D_{out} = 3.0V$; $VN = 0V$	2.5	5.0	10.0	k Ω
D_{out} Low Level Resistance	R_{DOL}	$V_{DD} = 1.8V$; $D_{out} = 0.5V$; $VN = 1.8V$	2.5	5.0	10.0	k Ω
Internal Resistance between VN and V_{DD}	R_{VND}	$V_{DD} = 1.8V$; $VN=0V$	100	300	900	k Ω
Internal Resistance between VN and GND	R_{VNG}	$V_{DD} = 3.5V$; $VN = 3.5V$	10	20	40	k Ω



AAT8660E DETECTION VOLTAGE AND DELAY TIME (25)

PARAMETER	SYMBOL	TEST CONDITION	MIN	TYP	MAX	UNIT
Over Charge Threshold Voltage	V_{C1}	Detect Rising Edge of Supply Voltage	4.230	4.280	4.330	V
Over Charge Release Voltage	V_{C2}	Detect Falling Edge of Supply Voltage	$V_{C1}-0.30$	$V_{C1}-0.20$	$V_{C1}-0.10$	V
Over Discharge Threshold Voltage	V_{D1}	Detect Falling Edge of Supply Voltage	2.201	2.281	2.361	V
Over Discharge Release Voltage	V_{D2}	Detect Rising Edge of Supply Voltage	$V_{D1}+0.5$	$V_{D1}+0.6$	$V_{D1}+0.7$	V
Over Charge Delay Time	t_{C1}	$V_{DD} = 3.6V$ to $4.5V$	0.700	1.000	1.300	s
Over Discharge Delay Time	t_{D1}	$V_{DD} = 3.6V$ to $2.4V$	87.5	125.0	162.5	ms
Over Current Level 1 Detection Voltage	V_{OC1}	Detect Rising Edge of “VN” Pin Voltage (D_{out} Response with t_{OC1} Delay Time)	80	100	120	mV
Over Current Level 2 Detection Voltage	V_{OC2}	Detect Rising Edge of “VN” Pin Voltage (D_{out} Response with t_{OC2} Delay Time)	400	480	600	mV
Short Circuit Detection Voltage	V_{short}	$V_{DD} = 3.0V$, Detect Rising Edge of “VN” Pin Voltage (D_{out} Response with t_{short} Delay Time)	$V_{DD}-1.7$	$V_{DD}-1.3$	$V_{DD}-0.9$	V
Over Current Level 1 Detection Delay Time	t_{OC1}	$V_{DD} = 3.0V$	5.6	8.0	10.4	ms
Over Current Level 2 Detection Delay Time	t_{OC2}	Room Temp. \Rightarrow Low or High Temp. \Rightarrow $V_{DD} = 3.0V$	1.4 1.1	2.0 2.0	2.6 3.4	ms ms
Short Circuit Detection Delay Time	t_{short}	$V_{DD} = 3.0V$		10	50	μ s
Charger Detection Voltage	V_{CHR}	Detect Rising Edge of “ D_{out} ” Pin Voltage (when $V_{D1} < V_{DD} < V_{D2}$)	-2.0	-1.3	-0.6	V
C_{out} High Level Resistance	R_{COH}	$V_{DD} = 3.5V$; $C_{out} = 3.0V$; $VN = 0V$	1	2	10	k Ω
C_{out} Low Level Resistance	R_{COL}	$V_{DD} = 4.5V$; $C_{out} = 0.5V$; $VN = 0V$	150	602	2,380	k Ω
D_{out} High Level Resistance	R_{DOH}	$V_{DD} = 3.5V$; $D_{out} = 3.0V$; $VN = 0V$	2.5	5.0	10.0	k Ω
D_{out} Low Level Resistance	R_{DOL}	$V_{DD} = 1.8V$; $D_{out} = 0.5V$; $VN = 1.8V$	2.5	5.0	10.0	k Ω
Internal Resistance between VN and V_{DD}	R_{VND}	$V_{DD} = 1.8V$; $VN = 0V$	100	300	900	k Ω
Internal Resistance between VN and GND	R_{VNG}	$V_{DD} = 3.5V$; $VN = 3.5V$	10	20	40	k Ω



AAT8660F DETECTION VOLTAGE AND DELAY TIME (25)

PARAMETER	SYMBOL	TEST CONDITION	MIN	TYP	MAX	UNIT
Over Charge Threshold Voltage	V_{C1}	Detect Rising Edge of Supply Voltage	4.275	4.325	4.375	V
Over Charge Release Voltage	V_{C2}	Detect Falling Edge of Supply Voltage	$V_{C1}-0.35$	$V_{C1}-0.25$	$V_{C1}-0.15$	V
Over Discharge Threshold Voltage	V_{D1}	Detect Falling Edge of Supply Voltage	2.420	2.500	2.580	V
Over Discharge Release Voltage	V_{D2}	Detect Rising Edge of Supply Voltage	$V_{D1}+0.3$	$V_{D1}+0.4$	$V_{D1}+0.5$	V
Over Charge Delay Time	t_{C1}	$V_{DD} = 3.6V$ to $4.5V$	0.700	1.000	1.300	s
Over Discharge Delay Time	t_{D1}	$V_{DD} = 3.6V$ to $2.4V$	87.5	125.0	162.5	ms
Over Current Level 1 Detection Voltage	V_{OC1}	Detect Rising Edge of “VN” Pin Voltage (D_{out} Response with t_{OC1} Delay Time)	80	100	120	mV
Over Current Level 2 Detection Voltage	V_{OC2}	Detect Rising Edge of “VN” Pin Voltage (D_{out} Response with t_{OC2} Delay Time)	400	480	600	mV
Short Circuit Detection Voltage	V_{short}	$V_{DD} = 3.0V$, Detect Rising Edge of “VN” Pin Voltage (D_{out} Response with t_{short} Delay Time)	$V_{DD}-1.7$	$V_{DD}-1.3$	$V_{DD}-0.9$	V
Over Current Level 1 Detection Delay Time	t_{OC1}	$V_{DD} = 3.0V$	5.6	8.0	10.4	ms
Over Current Level 2 Detection Delay Time	t_{OC2}	Room Temp. \Rightarrow Low or High Temp. \Rightarrow $V_{DD} = 3.0V$	1.4 1.1	2.0 2.0	2.6 3.4	ms ms
Short Circuit Detection Delay Time	t_{short}	$V_{DD} = 3.0V$		10	50	μ s
Charger Detection Voltage	V_{CHR}	Detect Rising Edge of “ D_{out} ” Pin Voltage (When $V_{D1} < V_{DD} < V_{D2}$)	-2.0	-1.3	-0.6	V
C_{out} High Level Resistance	R_{COH}	$V_{DD} = 3.5V$; $C_{out} = 3.0V$; $VN = 0V$	1	2	10	k Ω
C_{out} Low Level Resistance	R_{COL}	$V_{DD} = 4.5V$; $C_{out} = 0.5V$; $VN = 0V$	150	602	2,380	k Ω
D_{out} High Level Resistance	R_{DOH}	$V_{DD} = 3.5V$; $D_{out} = 3.0V$; $VN=0V$	2.5	5.0	10.0	k Ω
D_{out} Low Level Resistance	R_{DOL}	$V_{DD} = 1.8V$; $D_{out} = 0.5V$; $VN=1.8V$	2.5	5.0	10.0	k Ω
Internal Resistance between VN and V_{DD}	R_{VND}	$V_{DD} = 1.8V$; $VN = 0V$	100	300	900	k Ω
Internal Resistance between VN and GND	R_{VNG}	$V_{DD} = 3.5V$; $VN=3.5V$	10	20	40	k Ω



AAT8660G DETECTION VOLTAGE AND DELAY TIME (25)

PARAMETER	SYMBOL	TEST CONDITION	MIN	TYP	MAX	UNIT
Over Charge Threshold Voltage	V_{C1}	Detect Rising Edge of Supply Voltage	4.300	4.350	4.400	V
Over Charge Release Voltage	V_{C2}	Detect Falling Edge of Supply Voltage	$V_{C1}-0.30$	$V_{C1}-0.20$	$V_{C1}-0.10$	V
Over Discharge Threshold Voltage	V_{D1}	Detect Falling Edge of Supply Voltage	2.220	2.300	2.380	V
Over Discharge Release Voltage	V_{D2}	Detect Rising Edge of Supply Voltage	$V_{D1}+0.6$	$V_{D1}+0.7$	$V_{D1}+0.8$	V
Over Charge Delay Time	t_{C1}	$V_{DD} = 3.6V$ to $4.5V$	0.088	0.125	0.163	s
Over Discharge Delay Time	t_{D1}	$V_{DD} = 3.6V$ to $2.4V$	22.4	32.0	41.6	ms
Over Current Level 1 Detection Voltage	V_{OC1}	Detect Rising Edge of “VN” Pin Voltage (D_{out} Response with t_{OC1} Delay Time)	180	200	220	mV
Over Current Level 2 Detection Voltage	V_{OC2}	Detect Rising Edge of “VN” Pin Voltage (D_{out} Response with t_{OC2} Delay Time)	400	510	600	mV
Short Circuit Detection Voltage	V_{short}	$V_{DD} = 3.0V$, Detect Rising Edge of “VN” Pin Voltage (D_{out} Response with t_{short} Delay Time)	$V_{DD}-1.7$	$V_{DD}-1.3$	$V_{DD}-0.9$	V
Over Current Level 1 Detection Delay Time	t_{OC1}	$V_{DD} = 3.0V$	2.8	4	5.2	ms
Over Current Level 2 Detection Delay Time	t_{OC2}	Room Temp. \Rightarrow Low or High Temp. \Rightarrow $V_{DD} = 3.0V$	1.4 1.1	2.0 2.0	2.6 3.4	ms ms
Short Circuit Detection Delay Time	t_{short}	$V_{DD} = 3.0V$		10	50	μ s
Charger Detection Voltage	V_{CHR}	Detect Rising Edge of “ D_{out} ” Pin Voltage (when $V_{D1} < V_{DD} < V_{D2}$)	-2.0	-1.3	-0.6	V
C_{out} High Resistance Level	R_{COH}	$V_{DD} = 3.5V$; $C_{out} = 3.0V$; $VN=0V$	1	2	10	k Ω
C_{out} Low Resistance Level	R_{COL}	$V_{DD} = 4.5V$; $C_{out} = 0.5V$; $VN=0V$	150	602	2,380	k Ω
D_{out} High Resistance Level	R_{DOH}	$V_{DD} = 3.5V$; $D_{out} = 3.0V$; $VN=0V$	2.5	5.0	10.0	k Ω
D_{out} Low Resistance Level	R_{DOL}	$V_{DD} = 1.8V$; $D_{out} = 0.5V$; $VN=1.8V$	2.5	5.0	10.0	k Ω
Internal Resistance between VN and V_{DD}	R_{VND}	$V_{DD} = 1.8V$; $VN=0V$	100	300	900	k Ω
Internal Resistance between VN and GND	R_{VNG}	$V_{DD} = 3.5V$; $VN=3.5V$	10	20	40	k Ω



AAT8660H DETECTION VOLTAGE AND DELAY TIME (25)

PARAMETER	SYMBOL	TEST CONDITION	MIN	TYP	MAX	UNIT
Over Charge Threshold Voltage	V_{C1}	Detect Rising Edge of Supply Voltage	4.250	4.300	4.350	V
Over Charge Release Voltage	V_{C2}	Detect Falling Edge of Supply Voltage	$V_{C1}-0.30$	$V_{C1}-0.20$	$V_{C1}-0.10$	V
Over Discharge Threshold Voltage	V_{D1}	Detect Falling Edge of Supply Voltage	2.220	2.300	2.380	V
Over Discharge Release Voltage	V_{D2}	Detect rising Edge of Supply Voltage	$V_{D1}-0.08$	V_{D1}	$V_{D1}+0.08$	V
Over Charge Delay Time	t_{C1}	$V_{DD} = 3.6V$ to $4.5V$	0.700	1.000	1.300	s
Over Discharge Delay Time	t_{D1}	$V_{DD} = 3.6V$ to $2.4V$	87.5	125.0	162.5	ms
Over Current Level 1 Detection Voltage	V_{OC1}	Detect Rising Edge of “VN” Pin Voltage (D_{out} Response with t_{OC1} Delay time)	130	150	170	mV
Over Current Level 2 Detection Voltage	V_{OC2}	Detect rising Edge of “VN” Pin Voltage (D_{out} Response With t_{OC2} Delay Time)	400	500	600	mV
Short Circuit Detection Voltage	V_{short}	$V_{DD} = 3.0V$, Detect Rising Edge of “VN” Pin Voltage (D_{out} Response with t_{short} Delay Time)	$V_{DD}-1.7$	$V_{DD}-1.3$	$V_{DD}-0.9$	V
Over Current Level 1 Detection Delay Time	t_{OC1}	$V_{DD} = 3.0V$	5.6	8.0	10.4	ms
Over Current Level 2 Detection Delay Time	t_{OC2}	Room Temp. \Rightarrow Low or High Temp. \Rightarrow $V_{DD} = 3.0V$	1.4 1.1	2.0 2.0	2.6 3.4	ms ms
Short Circuit Detection Delay Time	t_{short}	$V_{DD} = 3.0V$		10	50	μ s
Charger Detection Voltage	V_{CHR}	Detect Rising Edge of “ D_{out} ” Pin Voltage (when $V_{D1} < V_{DD} < V_{D2}$)	-2.0	-1.3	-0.6	V
C_{out} High Resistance Level	R_{COH}	$V_{DD} = 3.5V$; $C_{out} = 3.0V$;VN=0V	1	2	10	k Ω
C_{out} Low Resistance Level	R_{COL}	$V_{DD} = 4.5V$; $C_{out} = 0.5V$;VN=0V	150	602	2,380	k Ω
D_{out} High Resistance Level	R_{DOH}	$V_{DD} = 3.5V$; $D_{out} = 3.0V$;VN=0V	2.5	5.0	10.0	k Ω
D_{out} Low Resistance Level	R_{DOL}	$V_{DD} = 1.8V$; $D_{out} = 0.5V$;VN=1.8V	2.5	5.0	10.0	k Ω
Internal Resistance between VN and V_{DD}	R_{VND}	$V_{DD} = 1.8V$; VN=0V	100	300	900	k Ω
Internal Resistance between VN and GND	R_{VNG}	$V_{DD} = 3.5V$; VN=3.5V	10	20	40	k Ω



AAT8660I DETECTION VOLTAGE AND DELAY TIME (25)

PARAMETER	SYMBOL	TEST CONDITION	MIN	TYP	MAX	UNIT
Over Charge Threshold Voltage	V_{C1}	Detect Rising Edge of Supply Voltage	4.250	4.300	4.350	V
Over Charge Release Voltage	V_{C2}	Detect Falling Edge of Supply Voltage	$V_{C1}-0.30$	$V_{C1}-0.20$	$V_{C1}-0.10$	V
Over Discharge Threshold Voltage	V_{D1}	Detect Falling Edge of Supply Voltage	2.220	2.300	2.380	V
Over Discharge Release Voltage	V_{D2}	Detect Rising Edge of Supply Voltage	$V_{D1}-0.08$	V_{D1}	$V_{D1}+0.08$	V
Over Charge Delay Time	t_{C1}	$V_{DD} = 3.6V$ to $4.5V$	0.700	1.000	1.300	s
Over Discharge Delay Time	t_{D1}	$V_{DD} = 3.6V$ to $2.4V$	87.5	125.0	162.5	ms
Over Current Level 1 Detection Voltage	V_{OC1}	Detect Rising Edge of “VN” Pin Voltage (D_{out} Response with t_{OC1} Delay Time)	110	130	150	mV
Over Current Level 2 Detection Voltage	V_{OC2}	Detect Rising Edge of “VN” Pin Voltage (D_{out} Response with t_{OC2} Delay Time)	400	490	600	mV
Short Circuit Detection Voltage	V_{short}	$V_{DD} = 3.0V$, Detect Rising Edge of “VN” Pin Voltage (D_{out} Response with t_{short} Delay Time)	$V_{DD}-1.7$	$V_{DD}-1.3$	$V_{DD}-0.9$	V
Over Current Level 1 Detection Delay Time	t_{OC1}	$V_{DD} = 3.0V$	5.6	8.0	10.4	ms
Over Current Level 2 Detection Delay Time	t_{OC2}	Room Temp. \Rightarrow Low or High Temp. \Rightarrow $V_{DD} = 3.0V$	1.4 1.1	2.0 2.0	2.6 3.4	ms ms
Short Circuit Detection Delay Time	t_{short}	$V_{DD} = 3.0V$		10	50	μ s
Charger Detection Voltage	V_{CHR}	Detect Rising Edge of “ D_{out} ” Pin Voltage (when $V_{D1} < V_{DD} < V_{D2}$)	-2.0	-1.3	-0.6	V
C_{out} High Resistance Level	R_{COH}	$V_{DD} = 3.5V$; $C_{out} = 3.0V$;VN=0V	1	2	10	k Ω
C_{out} Low Resistance Level	R_{COL}	$V_{DD} = 4.5V$; $C_{out} = 0.5V$;VN=0V	150	602	2,380	k Ω
D_{out} High Resistance Level	R_{DOH}	$V_{DD} = 3.5V$; $D_{out} = 3.0V$;VN=0V	2.5	5.0	10.0	k Ω
D_{out} Low Resistance Level	R_{DOL}	$V_{DD} = 1.8V$; $D_{out} = 0.5V$;VN=1.8V	2.5	5.0	10.0	k Ω
Internal Resistance between VN and V_{DD}	R_{VND}	$V_{DD} = 1.8V$; VN=0V	100	300	900	k Ω
Internal Resistance between VN and GND	R_{VNG}	$V_{DD} = 3.5V$; VN=3.5V	10	20	40	k Ω



AAT8660J DETECTION VOLTAGE AND DELAY TIME (25)

PARAMETER	SYMBOL	TEST CONDITION	MIN	TYP	MAX	UNIT
Over Charge Threshold Voltage	V_{C1}	Detect Rising Edge of Supply Voltage	4.230	4.280	4.330	V
Over Charge Release Voltage	V_{C2}	Detect Falling Edge of Supply Voltage	$V_{C1}-0.30$	$V_{C1}-0.20$	$V_{C1}-0.10$	V
Over Discharge Threshold Voltage	V_{D1}	Detect Falling Edge of Supply Voltage	2.201	2.281	2.361	V
Over Discharge Release Voltage	V_{D2}	Detect Rising Edge of Supply Voltage	$V_{D1}-0.08$	V_{D1}	$V_{D1}+0.08$	V
Over Charge Delay Time	t_{C1}	$V_{DD} = 3.6V$ to $4.5V$	0.700	1.000	1.300	s
Over Discharge Delay Time	t_{D1}	$V_{DD} = 3.6V$ to $2.4V$	87.5	125.0	162.5	ms
Over Current Level 1 Detection Voltage	V_{OC1}	Detect Rising Edge of “VN” Pin Voltage (D_{out} Response with t_{OC1} Delay Time)	180	200	220	mV
Over Current Level 2 Detection Voltage	V_{OC2}	Detect Rising Edge of “VN” Pin Voltage (D_{out} Response with t_{OC2} Delay Time)	400	510	600	mV
Short Circuit Detection Voltage	V_{short}	$V_{DD} = 3.0V$, Detect Rising Edge of “VN” Pin Voltage (D_{out} Response with t_{short} Delay Time)	$V_{DD}-1.7$	$V_{DD}-1.3$	$V_{DD}-0.9$	V
Over Current Level 1 Detection Delay Time	t_{OC1}	$V_{DD} = 3.0V$	5.6	8.0	10.4	ms
Over Current Level 2 Detection Delay Time	t_{OC2}	Room Temp. \Rightarrow Low or High Temp. \Rightarrow $V_{DD} = 3.0V$	1.4 1.1	2.0 2.0	2.6 3.4	ms ms
Short Circuit Detection Delay Time	t_{short}	$V_{DD} = 3.0V$		10	50	μ s
Charger Detection Voltage	V_{CHR}	Detect Rising Edge of “ D_{out} ” Pin Voltage (when $V_{D1} < V_{DD} < V_{D2}$)	-2.0	-1.3	-0.6	V
C_{out} High Level Resistance	R_{COH}	$V_{DD} = 3.5V$; $C_{out} = 3.0V$;VN=0V	1	2	10	k Ω
C_{out} Low Level Resistance	R_{COL}	$V_{DD} = 4.5V$; $C_{out} = 0.5V$;VN=0V	150	602	2,380	k Ω
D_{out} High Level Resistance	R_{DOH}	$V_{DD} = 3.5V$; $D_{out} = 3.0V$;VN=0V	2.5	5.0	10.0	k Ω
D_{out} Low Level Resistance	R_{DOL}	$V_{DD} = 1.8V$; $D_{out} = 0.5V$;VN=1.8V	2.5	5.0	10.0	k Ω
Internal Resistance between VN and V_{DD}	R_{VND}	$V_{DD} = 1.8V$; VN=0V	100	300	900	k Ω
Internal Resistance between VN and GND	R_{VNG}	$V_{DD} = 3.5V$; VN=3.5V	10	20	40	k Ω



SUMMARY OF AAT8660 DETECTION VOLTAGE AND DELAY TIME (25° C)

PARAMETER	SYMBOL	DEVICE	MIN	TYP	MAX	UNIT
Over Charge Threshold Voltage	V_{C1}	AAT8660A	4.275	4.325	4.375	V
		AAT8660B	4.300	4.350	4.400	V
		AAT8660C	4.250	4.300	4.350	V
		AAT8660D	4.230	4.280	4.330	V
		AAT8660E	4.230	4.280	4.330	V
		AAT8660F	4.275	4.325	4.375	V
		AAT8660G	4.300	4.350	4.400	V
		AAT8660H	4.250	4.300	4.350	V
		AAT8660I	4.250	4.300	4.350	V
		AAT8660J	4.230	4.280	4.330	V
		Over Charge Release Voltage	V_{C2}	AAT8660A	$V_{C1}-0.35$	$V_{C1}-0.25$
AAT8660B	$V_{C1}-0.30$			$V_{C1}-0.20$	$V_{C1}-0.10$	V
AAT8660C	$V_{C1}-0.30$			$V_{C1}-0.20$	$V_{C1}-0.10$	V
AAT8660D	$V_{C1}-0.30$			$V_{C1}-0.20$	$V_{C1}-0.10$	V
AAT8660E	$V_{C1}-0.30$			$V_{C1}-0.20$	$V_{C1}-0.10$	V
AAT8660F	$V_{C1}-0.35$			$V_{C1}-0.25$	$V_{C1}-0.15$	V
AAT8660G	$V_{C1}-0.30$			$V_{C1}-0.20$	$V_{C1}-0.10$	V
AAT8660H	$V_{C1}-0.30$			$V_{C1}-0.20$	$V_{C1}-0.10$	V
AAT8660I	$V_{C1}-0.30$			$V_{C1}-0.20$	$V_{C1}-0.10$	V
AAT8660J	$V_{C1}-0.30$			$V_{C1}-0.20$	$V_{C1}-0.10$	V
Over Discharge Threshold Voltage	V_{D1}			AAT8660A	2.420	2.500
		AAT8660B	2.220	2.300	2.380	V
		AAT8660C	2.220	2.300	2.380	V
		AAT8660D	2.201	2.281	2.361	V
		AAT8660E	2.201	2.281	2.361	V
		AAT8660F	2.420	2.500	2.580	V
		AAT8660G	2.220	2.300	2.380	V
		AAT8660H	2.220	2.300	2.380	V
		AAT8660I	2.220	2.300	2.380	V
		AAT8660J	2.201	2.281	2.361	V



SUMMARY OF AAT8660 DETECTION VOLTAGE AND DELAY TIME (25)

PARAMETER	SYMBOL	DEVICE	MIN	TYP	MAX	UNIT
Over Discharge Release Voltage	V_{D2}	AAT8660A	$V_{D1}+0.3$	$V_{D1}+0.4$	$V_{D1}+0.5$	V
		AAT8660B	$V_{D1}+0.6$	$V_{D1}+0.7$	$V_{D1}+0.8$	V
		AAT8660C	$V_{D1}-0.08$	V_{D1}	$V_{D1}+0.08$	V
		AAT8660D	$V_{D1}-0.08$	V_{D1}	$V_{D1}+0.08$	V
		AAT8660E	$V_{D1}+0.5$	$V_{D1}+0.6$	$V_{D1}+0.7$	V
		AAT8660F	$V_{D1}+0.3$	$V_{D1}+0.4$	$V_{D1}+0.5$	V
		AAT8660G	$V_{D1}+0.6$	$V_{D1}+0.7$	$V_{D1}+0.8$	V
		AAT8660H	$V_{D1}-0.08$	V_{D1}	$V_{D1}+0.08$	V
		AAT8660I	$V_{D1}-0.08$	V_{D1}	$V_{D1}+0.08$	V
		AAT8660J	$V_{D1}-0.08$	V_{D1}	$V_{D1}+0.08$	V
		Over Charge Delay Time	t_{C1}	AAT8660A	0.700	1.000
AAT8660B	0.088			0.125	0.163	s
AAT8660C	0.700			1.000	1.300	s
AAT8660D	0.700			1.000	1.300	s
AAT8660E	0.700			1.000	1.300	s
AAT8660F	0.700			1.000	1.300	s
AAT8660G	0.088			0.125	0.163	s
AAT8660H	0.700			1.000	1.300	s
AAT8660I	0.700			1.000	1.300	s
AAT8660J	0.700			1.000	1.300	s
Over Discharge Delay Time	t_{D1}			AAT8660A	87.5	125.0
		AAT8660B	22.4	32.0	41.6	ms
		AAT8660C	87.5	125.0	162.5	ms
		AAT8660D	87.5	125.0	162.5	ms
		AAT8660E	87.5	125.0	162.5	ms
		AAT8660F	87.5	125.0	162.5	ms
		AAT8660G	22.4	32.0	41.6	ms
		AAT8660H	87.5	125.0	162.5	ms
		AAT8660I	87.5	125.0	162.5	ms
		AAT8660J	87.5	125.0	162.5	ms

**SUMMARY OF AAT8660 DETECTION VOLTAGE AND DELAY TIME (25)**

PARAMETER	SYMBOL	DEVICE	MIN	TYP	MAX	UNIT
Over Current Level 1 Detection Voltage	V_{OC1}	AAT8660A	130	150	170	mV
		AAT8660B	130	150	170	mV
		AAT8660C	80	100	120	mV
		AAT8660D	110	130	150	mV
		AAT8660E	80	100	120	mV
		AAT8660F	80	100	120	mV
		AAT8660G	180	200	220	mV
		AAT8660H	130	150	170	mV
		AAT8660I	110	130	150	mV
		AAT8660J	180	200	220	mV
Over Current Level 2 Detection Voltage	V_{OC2}	AAT8660A	400	500	600	mV
		AAT8660B	400	500	600	mV
		AAT8660C	400	480	600	mV
		AAT8660D	400	490	600	mV
		AAT8660E	400	480	600	mV
		AAT8660F	400	480	600	mV
		AAT8660G	400	510	600	mV
		AAT8660H	400	500	600	mV
		AAT8660I	400	490	600	mV
		AAT8660J	400	510	600	mV
Over Current Level 1 Detection Delay Time	t_{OC1}	AAT8660A	5.6	8.0	10.4	ms
		AAT8660B	2.8	4.0	5.2	ms
		AAT8660C	5.6	8.0	10.4	ms
		AAT8660D	5.6	8.0	10.4	ms
		AAT8660E	5.6	8.0	10.4	ms
		AAT8660F	5.6	8.0	10.4	ms
		AAT8660G	2.8	4.0	5.2	ms
		AAT8660H	5.6	8.0	10.4	ms
		AAT8660I	5.6	8.0	10.4	ms
		AAT8660J	5.6	8.0	10.4	ms



TIMING CHART
AAT8660 (CHARGE AND DISCHARGE)

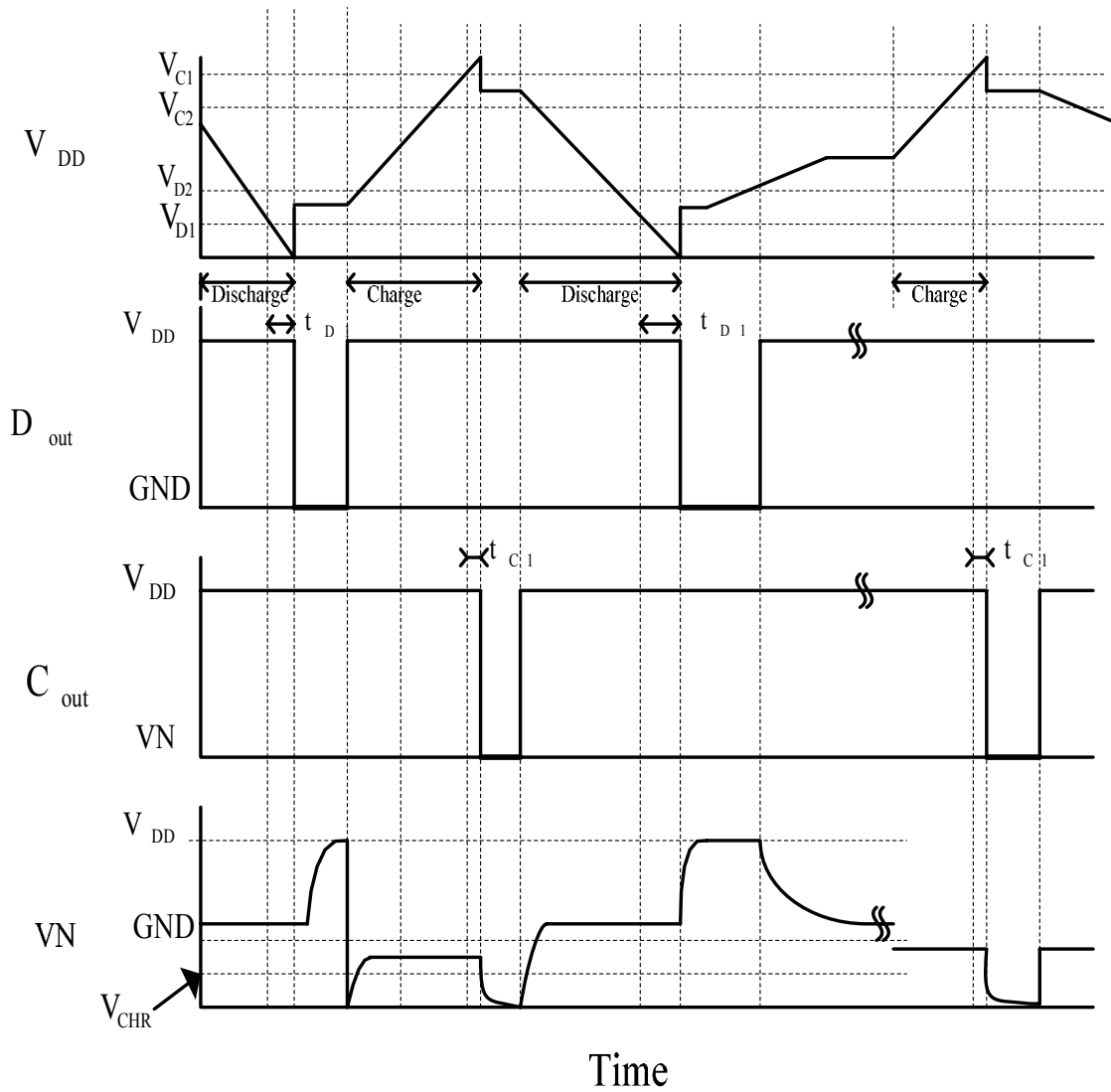



TIMING CHART

AAT8660 (UNUSUAL CHARGE CURRENT, OVER CURRENT, SHORT CIRCUIT)

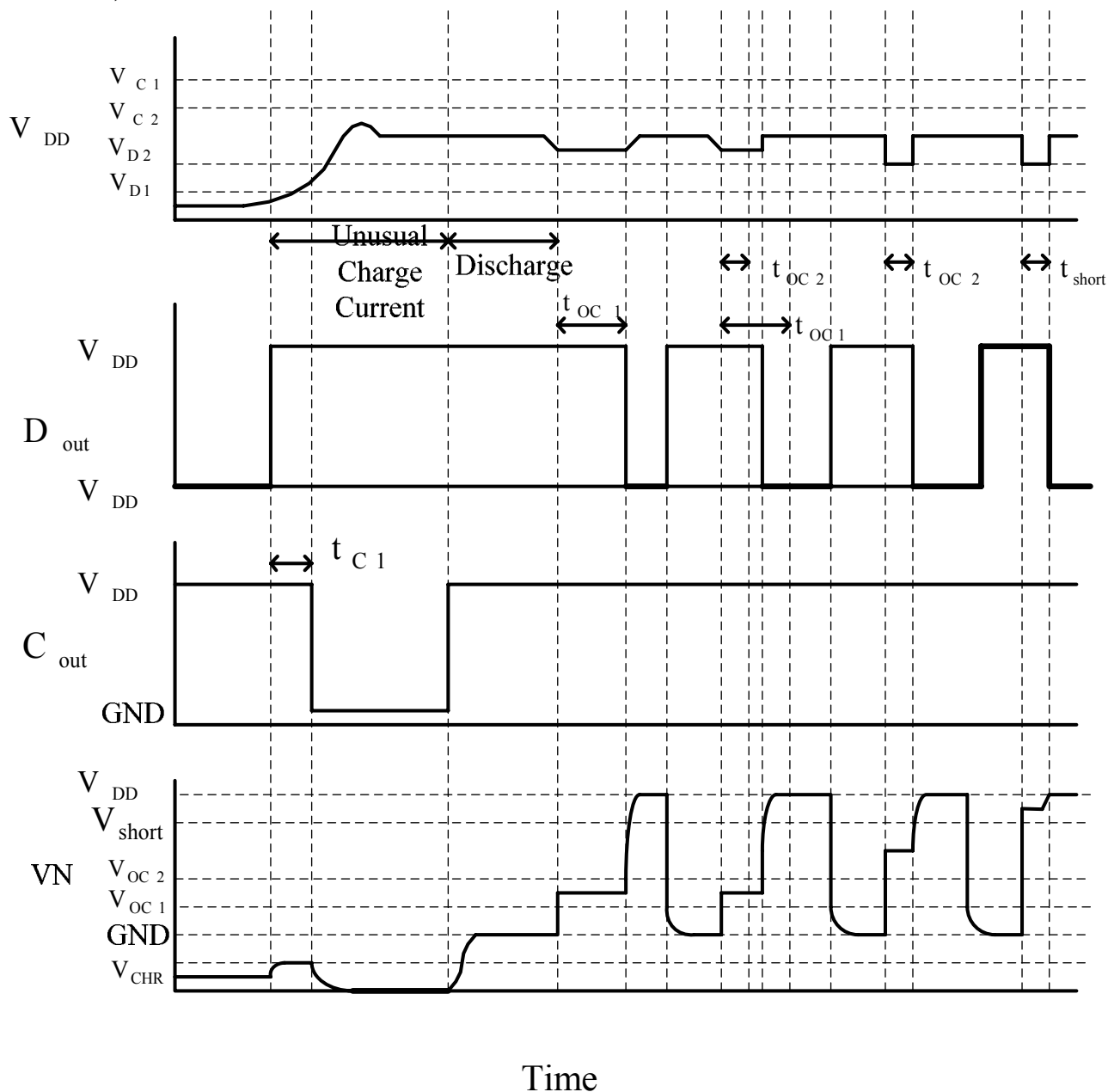



TYPICAL APPLICATION

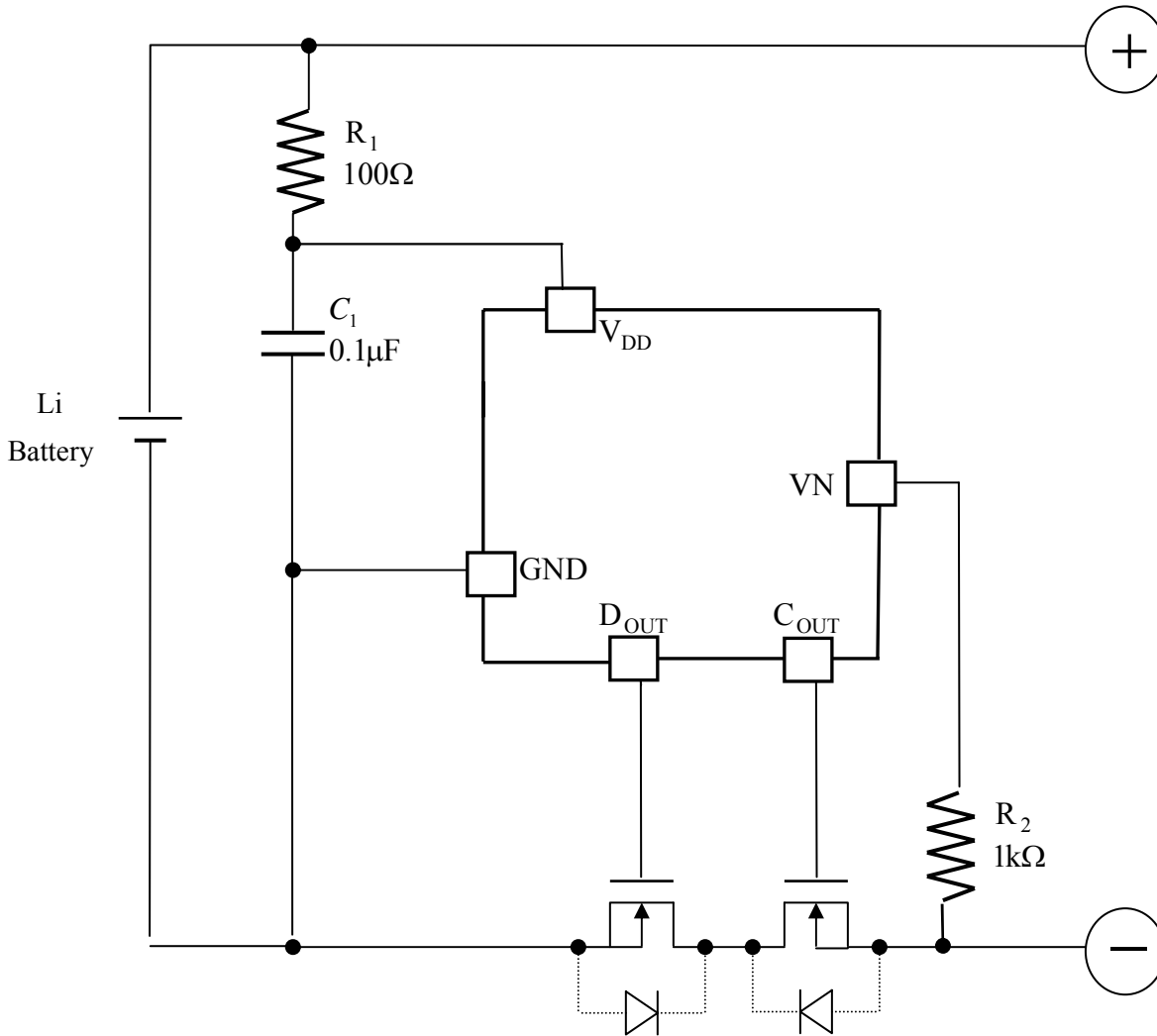



PACKAGE DIMENSION

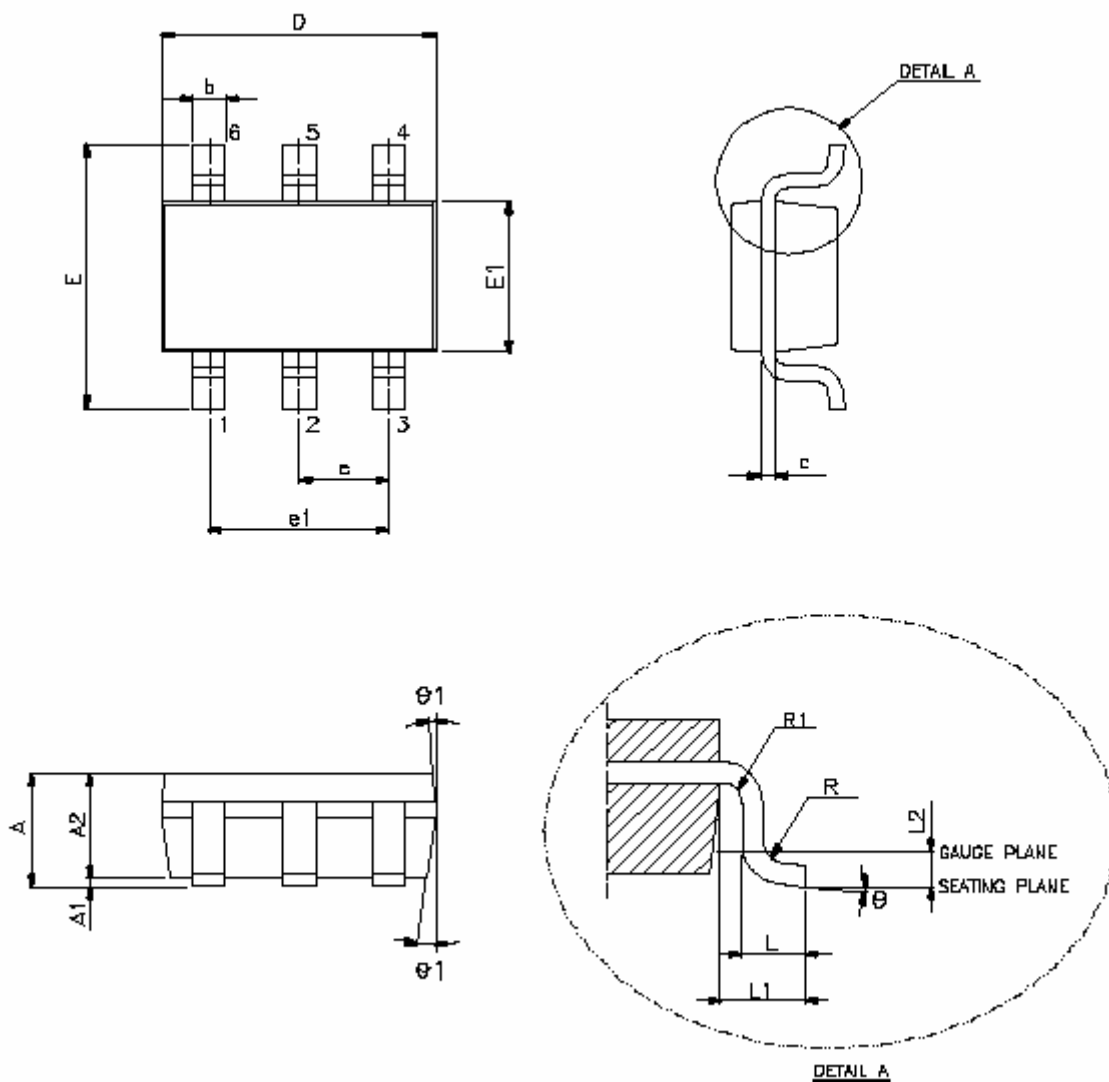



PACKAGE DIMENSIONS (CONT.)

VARIATION (ALL DIMENSIONS SHOWN IN MILLIMETERS)

SYMBOL	MIN	TYP	MAX
A	-----	-----	1.45
A1	-----	-----	0.15
A2	0.90	1.15	1.30
b	0.30	-----	0.50
c	0.08	-----	0.22
D	2.90 BSC		
E	2.80 BSC		
E1	1.60 BSC		
e	0.95 BSC		
e1	1.90 BSC		
L	0.30	0.45	0.60
L1	0.60 REF		
L2	0.25 BSC		
R	0.10	-----	-----
R1	0.10	-----	0.25
θ	0°	4°	8°
θ1	5°	10°	15°

NOTE:

1 JEDEC OUTLINE: MO-178 AB



TAPE AND REEL

PACKING METHOD: 3,000PCS/REEL, 5 REELS/BOX

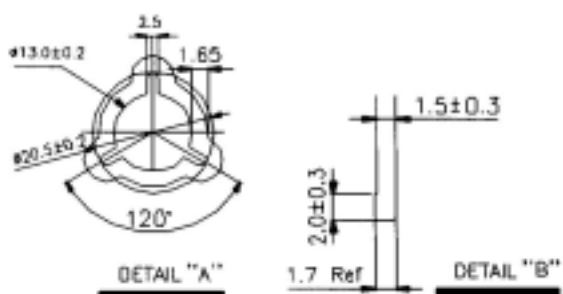
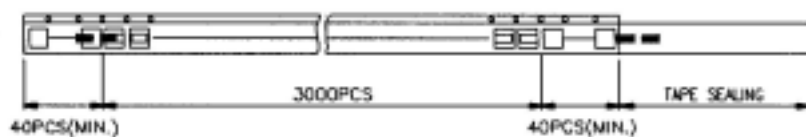
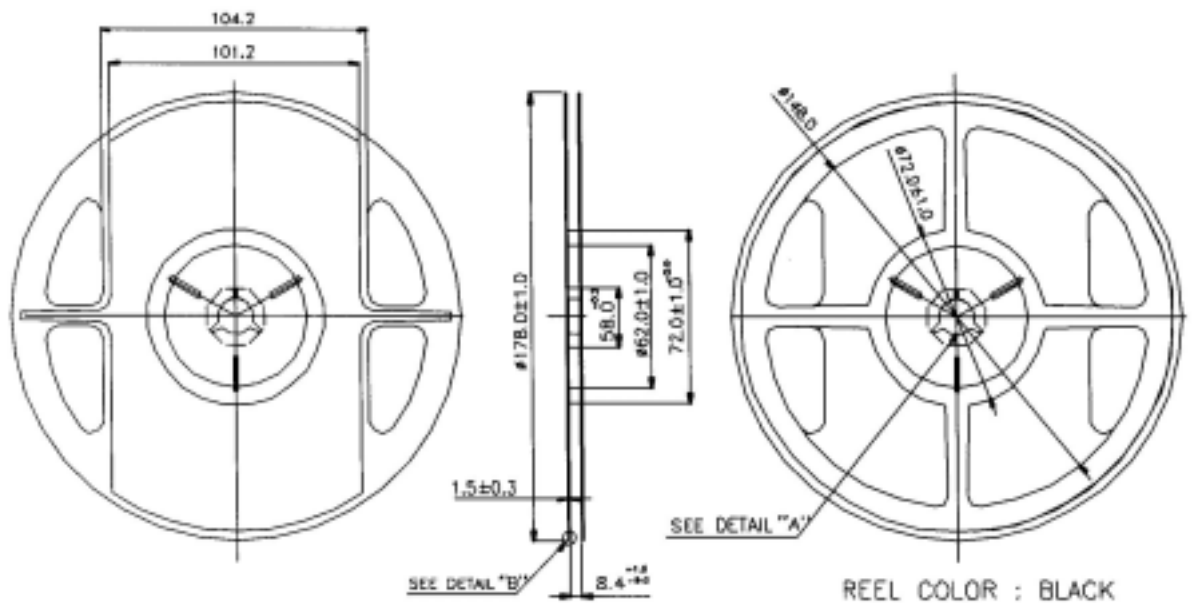



TAPE AND REEL (CONT.)

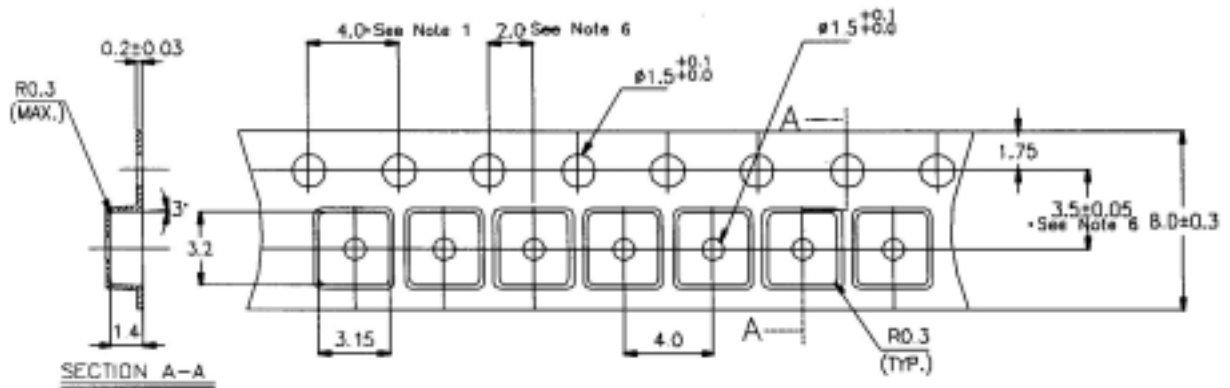
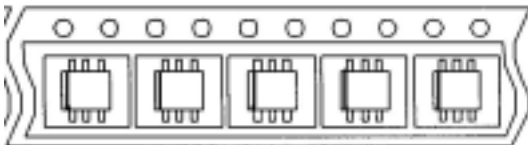

X.XXX X	± 0.0025
X.XXX	± 0.006
X.XX	± 0.025
X.X	± 0.10
X	± 0.25

UNIT: MILLIMETERS



PART MARKING

PREVIOUS SOT26 TOP MARKING

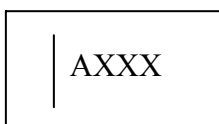

NOTE: SOT26 HAS NO BACK MARKING.

CURRENT SOT26 TOP MARKING

